

1000,-

30
JAHRE
YEARS ANN

KSTOOLS

No Limits!



2v1



1.0000+
šrouby

Včetně
25
bitů

1000,-

515.6500

5x rychlejší než manuální

TRANSFORMÁTOR MEZI ŠROUBOVÁKY

i **397**
Další informace

P₁₀

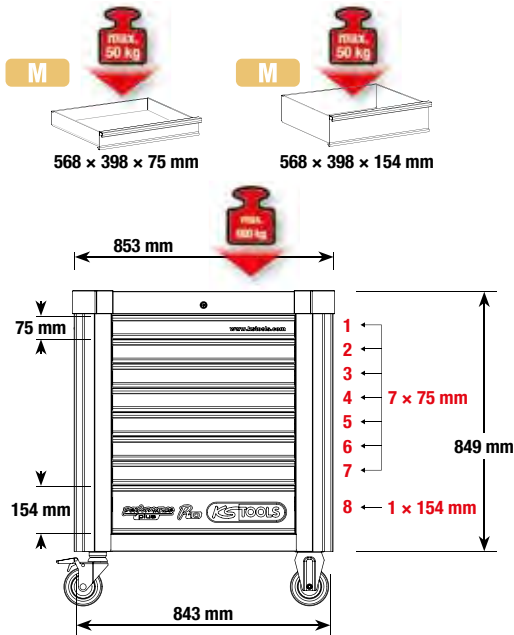

Integrovaná ochrana hran

VYBERTE SI SVOU KOMPLETNÍ SADU >>>

810.7397

i **397**
Další informace

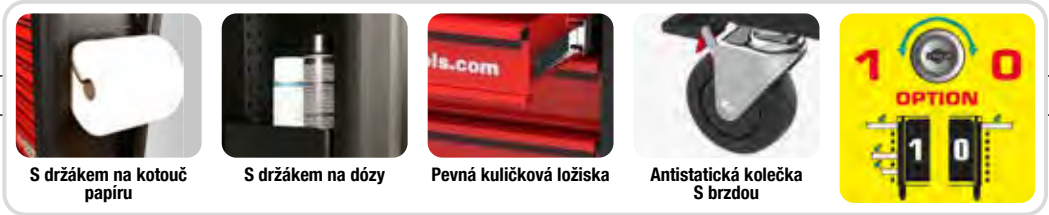

P₁₅

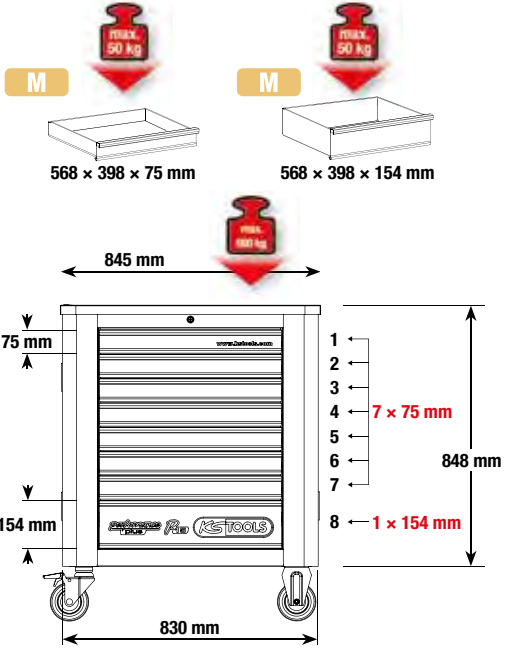

815.7397

PERFEKTNÍ SADA SLOŽENÁ Z 397 DÍLŮ

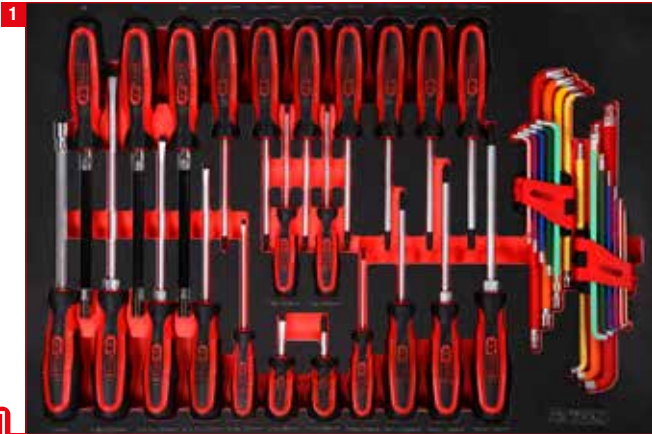

41 Souprava šroubováků



41 Souprava klíčů na šrouby

67480,-

810.7397 Dílenský vozík P10, včetně 397 kusů nářadí



111 1/4" + 3/8" + 1/2" Souprava nástrčných klíčů

69980,-

815.7397 Dílenský vozík P15, včetně 397 kusů nářadí



111 Souprava nástrčných ořechů s bity 1/2"



28 Souprava kleští a pilníků



43 Souprava na výměnu oleje a servis pneumatik

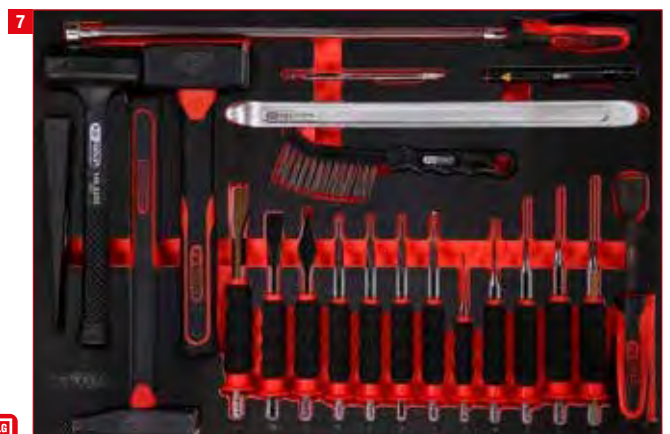

22 Souprava kladiv a dlát

SRDEČNĚ VÁS VÍTÁME V

i  **564**
Další informace



94980,-

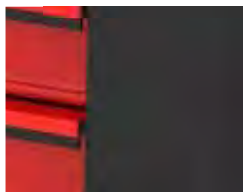

Integrovaná ochrana hran



S držákem na dózy

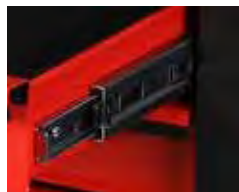

Pevná kuličková ložiska



Antistatická kolečka S brzdou



Uzamykatelný zámek

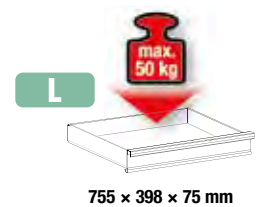
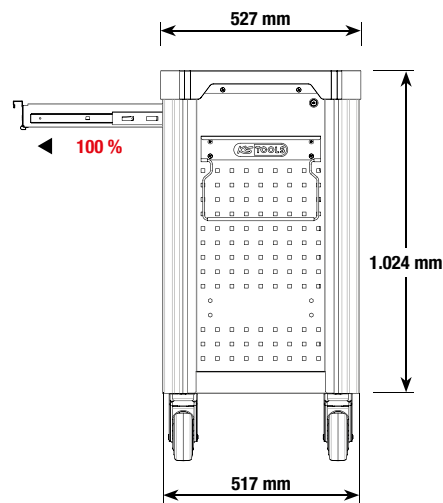
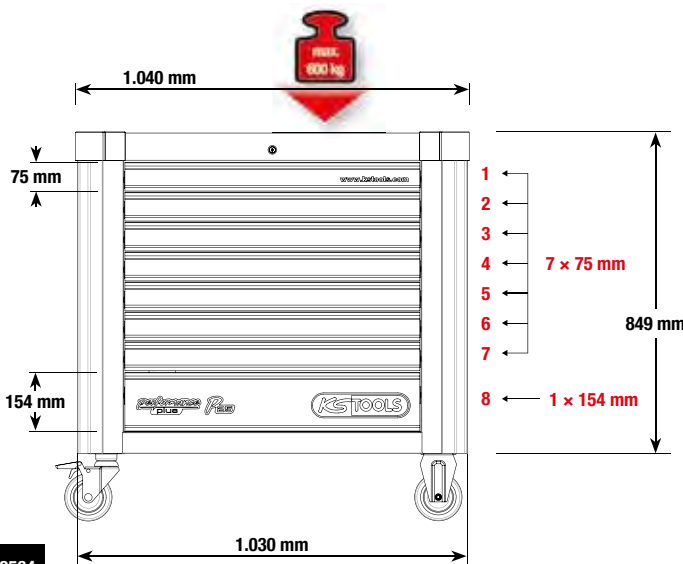

825.8564

KRÁLOVSKÉ TŘÍDĚ!

Performance
plus

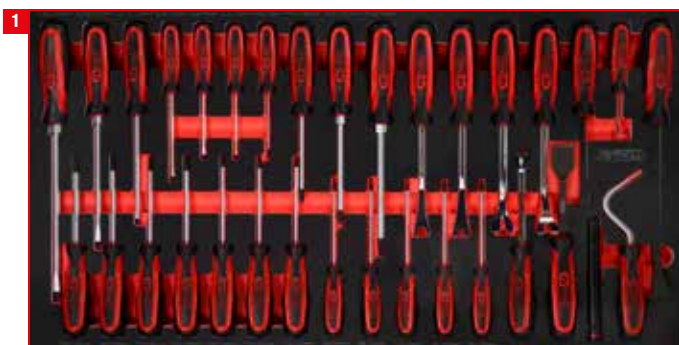

Souprava šroubováků

33



1/4" + 3/8" Souprava nástrčných klíčů

213



1/2" Souprava nástrčných klíčů

86



Souprava klíčů na šrouby

57



Souprava klíčů na šrouby

54

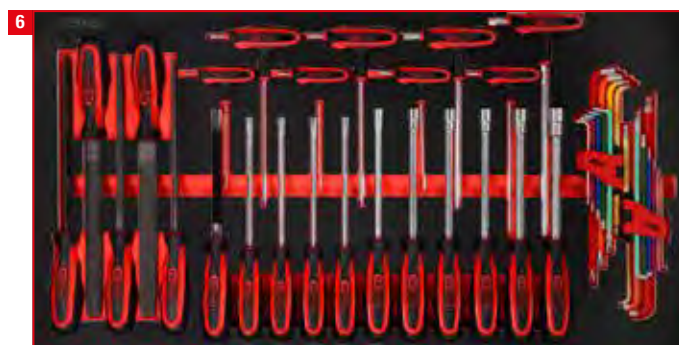

Souprava šroubováků a pilníků

42

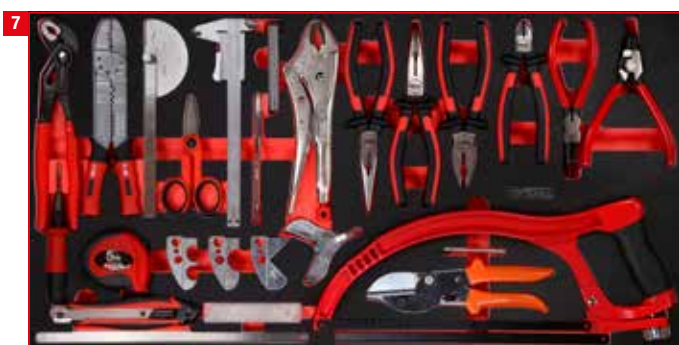

Souprava kleští a měřicího nářadí

39



Souprava kladiv, dlát a silových nástrčných ořechů

40

ECO *line*

Se 7 zásuvkami a 215dílnou soupravou nářadí Premium

17000,-

897.7215

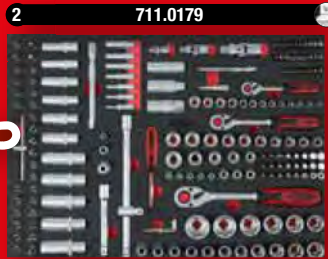

STARTOVACÍ SADA, 215DÍLNÁ



Další informace

RACING *line*

Se 7 zásuvkami a 215dílnou soupravou nářadí Premium

17500,-

826.7215



UNIVERZÁLNÍ SADA, 515DÍLNÁ

ECO *line*

Se 7 zásuvkami a 515dílnou soupravou nářadí Premium

22000,-

897.7515

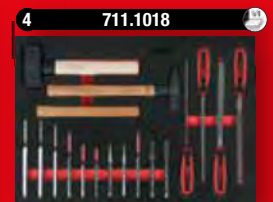
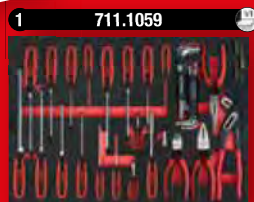

RACING *line*

Se 7 zásuvkami a 515dílnou soupravou nářadí Premium

22500,-

826.7515

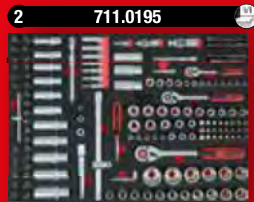

Další informace

ECO *line*

Se 7 zásuvkami a 598dílnou soupravou nářadí Premium

32480,-

897.7598

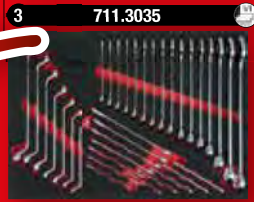
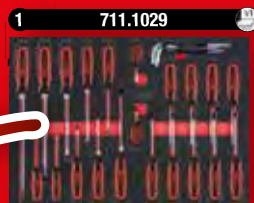

KOMPLETNÍ SADA, 215DÍLNÁ

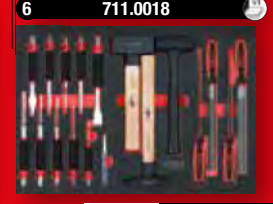
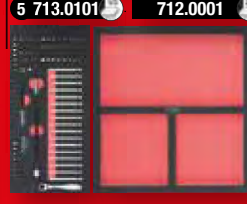

RACING *line*

Se 7 zásuvkami a 598dílnou soupravou nářadí Premium

33730,-

826.7598



Další informace

KOLIK VOZÍKŮ TO BUDE?

ECO *line*



Další informace

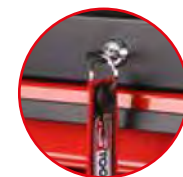
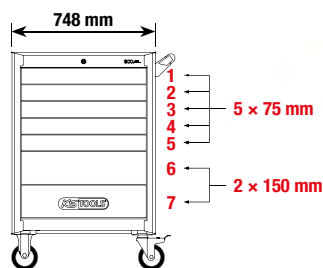
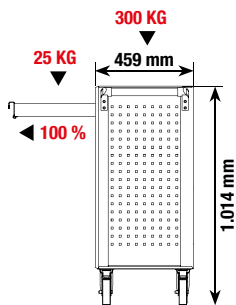

pracovní deska s vložkou z pěnové hmoty o tloušťce 10 mm

uzavírání s integrovaným válcovým zámekem



Čtvercové otvory pro příslušenství



S automatickým zasunutím a funkcí SOFT-CLOSE



2 x s pohyblivou a otočnou brzdou, Ø kol: 125 mm

SLOŽITÝ VÝBĚR? VOLTE PODLE KVALITY!

RACING *line*

max. 350 kg

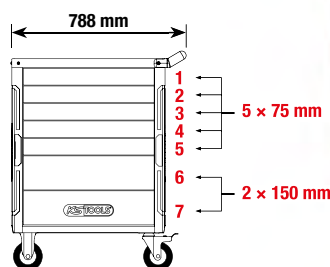
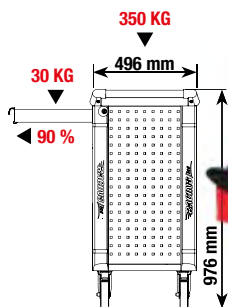

pracovní plocha z ABS s přihrádkami na malé díly



uzavírání s integrovaným válcovým zámekem



Čtvercové otvory pro příslušenství



individuální zamykání bránící neúmyslnému otevření



2 x s pohyblivou a otočnou brzdou, Ø kol: 125 mm

Technické údaje:	Eco Line 897.0007	Racing Line 826.0007
Celková nosnost:	300,0 kg	350,0 kg
Zatížení každé zásuvky:	25,0 kg	30,0 kg
automatickým zasunutím a funkcí SOFT-CLOSE:	✓	✗
Průměr kola:	125,0 mm	125,0 mm
Nastavovač kola:	✓	✓
S centrální pojistkou:	✓	✓
Jedna pojistka:	✗	✓
Výška:	1014,0 mm	976,0 mm
Šířka:	748 mm	788 mm
Hloubka:	459,0 mm	496,0 mm
Vnitřní rozměr zásuvky:	565 x 395 mm	565 x 395 mm
s polyuretanovou ochranou rohů a hran:	✗	✓
Čtvercové otvory pro příslušenství:	✓	✓
Počet zásuvek:	7	7
tloušťka plechu:	0,8 mm	0,9 mm
uchopovací lišta:	✓	✓
Zásuvkový výsuv:	100 %	90 %
Pracovní deska s oddíly na malé díly:	✗	✓
Pracovní deska s vložkami z pěnové hmoty:	✓	✗
vedení zásuvek s kuličkovými ložisky:	✓	✓
s kovovou rukojetí na straně:	✓	✓



Další informace



od 580,-



517.0048			8 · 9 · 10 · 11 · 13 · 14 · 17 · 19 mm	580,- CZK
517.0052			8 · 9 · 10 · 11 · 12 · 13 · 14 · 15 · 16 · 17 · 18 · 19 mm	1080,- CZK

- profil FlankTraction
- svěrná čelist zahnutá o 15°
- očko zahnuté o 15°
- leštěné hlavy
- matné satinování



Další informace



2740,-



517.0043 6 · 7 · 8 · 9 · 10 · 11 · 12 · 13 · 14 · 15 · 16 · 17 · 18 · 19 · 20 · 21 · 22 · 24 · 27 · 30 · 32 mm



Další informace

380,-



522.1922



Další informace

OBOUSTRANNÁ RÁČNA 4V1

500,-



503.4565 10 x 13 x 17 x 19 mm



Další informace

VŠESTRANNÝ POMOČNÍK

Jednoruční multifunkční klíč



850,-

114.0055



8 · 9 · 10 · 11 · 12 · 13 · 14 · 15 · 16 · 17 · 18 · 19 · 20 · 21 · 22 · 23 · 24 · 25 · 26 · 27 · 28 · 29 · 30 · 31 · 32 mm



Další informace

VŠEUMĚL

4230,-

GEAR plus RING STOP



1/4"

3/8"

1/2"

5/16"

10 mm



1/4" x 10 mm



5/16" x 13 mm



10 mm x 13 mm



1/4" x 10 mm



3/8" x 13 mm



1/2" x 19 mm



8 · 9 · 10 · 11 · 12 · 13 · 14 · 15 · 16 · 17 · 18 · 19 mm

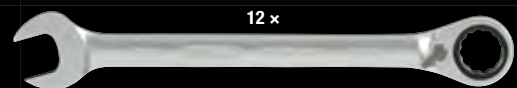

12 x

8 - 19 mm

8 - 19 mm

503.4960

LET'S TALK ABOUT SIX!

Víme, co umíme. A protože docela přesně víme, jak dobrá je naše nová řada ráčen Monster, můžeme vám s naprostým klidem poskytnout záruku na každý kus nářadí z této řady. Ne 2, ani 3 roky. Ale rovnou **10 let!** Protože si myslíme, že záruka by měla být stejně **prémiová**, jako jsou naše ráčny **Monster!**



INOVATIVNÍ RÁČNOVÝ MECHANISMUS

Naše inovativní technologie dvou čepů zamezuje prokluzování ráčnového mechanismu. Speciální maziva jsou zárukou dlouhé životnosti mechanického ústrojí.

UZAVŘENÉ MECHANICKÉ ÚSTROJÍ V HLAVĚ RÁČNY

Přesná výroba nářadí s minimálními přípustnými odchylkami v kombinaci se speciálním těsněním spolehlivě chrání před průnikem nečistot.



KULIČKOVÁ POJISTKA NA ČTYŘHRANU

Mimořádně vysoká spolehlivost: Čtyřhran spolehlivě přidrží vložky nástrčných klíčů s naprosto minimální vůlí.

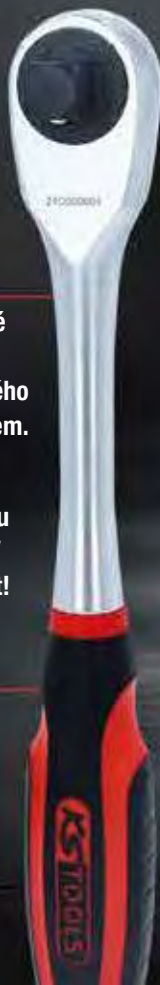

JEDINEČNÉ

Každé zboží je stejně jedinečné jako vy; provádíme kontrolu každého jednotlivého vyrobeného kusu s vlastním výrobním číslem.

Abyste se mohli na svou ráčnu Monster dlouho spolehnout. V ideálním případě po celý život!

Ergonomicky tvarovaná rukojeť z několika materiálů pro rychlou a bezpečnou práci.

0 15 % UŽŠÍ

V mnoha pracovních situacích záleží na každém milimetru. Hlavy našich nových ráčen jsou asi v porovnání se standardními modely asi o 15 % užší. Perfektní pro práci ve stísněných podmínkách!



0 10 % LEHČÍ

Nové ráčny Monster KS TOOLS jsou důkazem, že k hlasité muzice nepotřebujete těžký nástroj. Přednosti: Efektivní práce s minimální únavou.

TO NEJLEPŠÍ, CO JSME KDY VYROBILI!



1 **750,-** **1**
Další informace

935.1490 106 g 125 mm **>110 Nm**

2 **750,-** **1**
Další informace

935.1495 106 g 125 mm **>100 Nm**

3 **1000,-** **1**
Další informace

>365 Nm 935.3890 227 g 199 mm

**ZÁRUKA:
6 RÁČEN
MONSTER NA
CELÝ ŽIVOT!**



4 **1250,-** **1**
Další informace

>950 Nm 935.1290 567 g 275 mm

5 **1750,-** **1**
Další informace

>950 Nm 935.1295 757 g 425 mm

6 **2500,-** **1**
Další informace

TELESKOPICKÝ VÝSUV

635 607 582 557 533 508 482 457 431 406 mm **>950 Nm** 935.1285 1.280 g 406 - 635 mm

NÁŠ NEJPRODÁVANĚJŠÍ VÝROBEK



Další informace



700,-

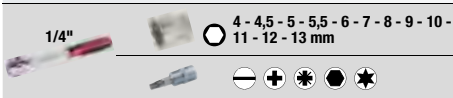

917.0648



Další informace



poniklováno

**UŽ VÍCE NEŽ
1 MILION
PRODANÝCH KUSŮ!**

2750,-



1/4"	○ 4 - 4,5 - 5 - 5,5 - 6 - 7 - 8 - 9 - 10 - 11 - 12 - 13 - 14 mm
1/4"	○ 6 - 7 - 8 - 9 - 10 - 11 - 12 - 13 mm
3/8"	○ 10 - 11 - 12 - 13 - 14 - 15 - 16 - 17 - 18 - 19 mm
1/2"	○ 10 - 11 - 12 - 13 - 14 - 15 - 16 - 17 - 18 - 19 - 20 - 21 - 22 - 23 - 24 - 27 - 30 - 32 mm
1/4" / 5/16"	○ 16 - 17 - 18 - 19 - 22 mm

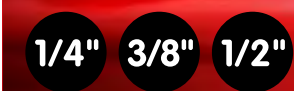



Další informace

LÉPE UŽ TO NEJDE!



poniklováno



1/4"		4 - 4,5 - 5 - 5,5 - 6 - 7 - 8 - 9 - 10 - 11 - 12 - 13 - 14 mm
		6 - 7 - 8 - 9 - 10 - 11 - 12 - 13 - 14 - 15 mm
3/8"		10 - 11 - 12 - 13 - 14 - 15 - 16 - 17 - 18 - 19 mm
		10 - 11 - 12 - 13 - 14 - 15 mm
1/2"		10 - 11 - 12 - 13 - 14 - 15 - 17 - 18 - 19 - 20 - 21 - 22 - 24 - 27 - 30 - 32 mm
		17 - 19 - 22 mm
1/4"		
5/16"		
12 x		8 - 9 - 10 - 11 - 12 - 13 - 14 - 15 - 16 - 17 - 18 - 19 mm

4380,-

1/4" 3/8" 1/2"

917.0216



Další informace

VELKÝ POMOCNÍK PŘI ŘEŠENÍ PROBLÉMŮ!

16 x		19 - 21 - 22 - 23 - 24 - 26 - 27 - 29 - 30 - 32 - 35 - 36 - 38 - 41 - 46 - 50 mm
3 x		100 - 200 - 400 mm
1 x		450 mm
1 x		500 mm



5500,-

500 mm

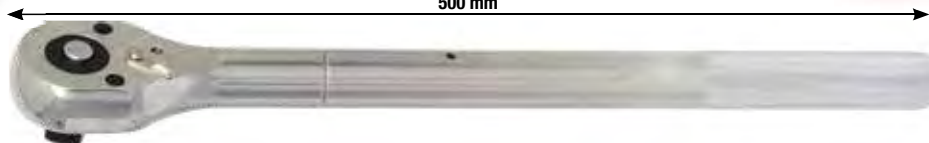

3/4"

911.0721



Další informace

GENIÁLNĚ UNIVERZÁLNÍ!



1/4"		4 - 4,5 - 5 - 5,5 - 6 - 7 - 8 - 9 - 10 - 11 - 12 - 13 mm
1/2"		10 - 11 - 12 - 13 - 14 - 15 - 16 - 17 - 19 - 20 - 21 - 22 - 24 - 27 - 30 - 32 mm
12 x		8 - 9 - 10 - 11 - 12 - 13 - 14 - 15 - 16 - 17 - 18 - 19 mm
7 x		

1/4" 1/2"

4380,-

917.0797



Další informace

KUFRÍK PRO MISTŘI ŘEMESLA!



4 x



8 x 8 - 9 - 10 - 11 - 13 - 14 - 17 - 19 mm



1/4"		4 - 4,5 - 5 - 5,5 - 6 - 7 - 8 - 9 - 10 - 11 - 12 - 13 - 14 mm
1/2"		10 - 13 - 14 - 16 - 17 - 18 - 19 - 20 - 22 - 24 - 27 - 30 - 32 mm

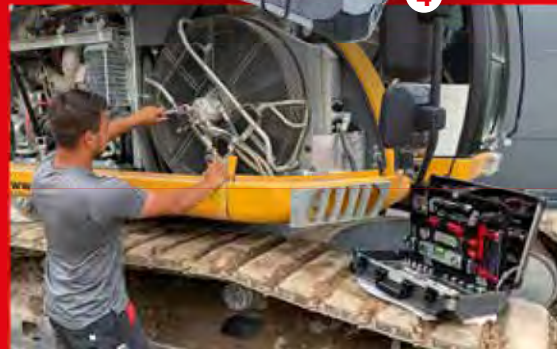

1/4" 1/2"

9330,-

911.0727





i  **99**
Další informace

TRUHLY S POKLADEM!

i  **99**
Další informace



 1/4"	4 - 5 - 6 - 7 - 8 - 9 - 10 - 11 - 12 - 13 - 14 mm
 1/2"	13 - 15 - 17 - 18 - 19 - 20 - 21 - 22 - 24 - 27 - 30 - 32 mm



**MÁTE NA
VYBRANOU.**

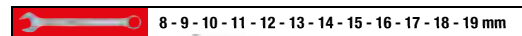
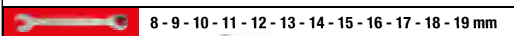

15000,-

13000,-

1/4" 1/2"

1/4" 1/2"

918.0100 

918.0200 

i  **40**
Další informace



1/2"

2880,-

515.0065

VYSOCE PŘESNÉ MOMENTOVÉ KLÍČE



Další informace

ERGOTORQUE PRECISION



Stupnice s lupou

Mikrometrická stupnice



Všetchné prohlášení o shodě pro kalibraci
DIN EN ISO 6789
Certifikát
Přesnost ±0,2%



od **2500,-**

			Nm	Dílek Nm	Lbf-ft	
516.1402		1/4"	1-5	0,10	0,8 - 3,6	2500,- CZK
516.1412		1/4"	5-25	0,10	0,8 - 18	2500,- CZK
516.1422		3/8"	10-50	0,25	4 - 37	2500,- CZK
516.1432		1/2"	20-100	0,50	8 - 75	2780,- CZK
516.1442		1/2"	40-200	1,00	15 - 150	2780,- CZK
516.1472		1/2"	60-320	1,00	45 - 236	3130,- CZK
516.1482		1/2"	80-420	1,00	60 - 310	3400,- CZK
516.1493		3/4"	150-750	10,00	150 - 550	14730,- CZK
516.1495		1"	200-1000	20,00	220 - 730	16850,- CZK



Další informace

22 NEJDŮLEŽITĚJŠÍCH V JEDNÉ SADĚ



330,-

151.4000

1,27 - 1,5 - 2 - 2,5 - 3 - 3,5 - 4 - 4,5 - 5 - 6 - 7 - 8 - 10 mm

TB10 - TB15 - TB20 - TB25 - TB27 - TB30 - TB40 - TB45 - TB50

i  **34**
Další informace

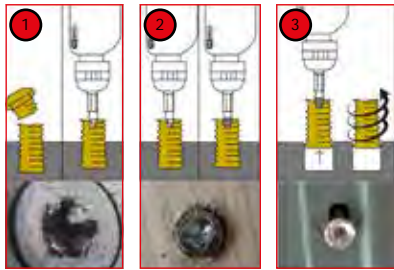

JSEM ŠROUB, DOSTAŇ MĚ ODSUD!



1130,-

TORION power







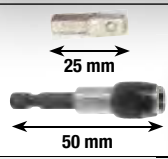

9 x		TE10 - TE15 - TE20 - TE25 - TE27 - TE30 - TE40 - TE50 - TE55
9 x		1,5 - 2 - 2,5 - 3 - 4 - 5 - 6 - 8 - 10 mm
7 x		1,5 - 2 - 2,5 - 3 - 4 - 5 - 6 mm
7 x		T10 - T15 - T20 - T25 - T27 - T30 - T40

150.7060    **1/4" + 10 mm Souprava vytahováků na šrouby Torx a šrouby s vnitřním šestihranem**

i  **32**
Další informace



1 x		50 mm
1 x		25 mm
3 x		PH1 - PH2 - PH3
6 x		2 x PZ1 - 2 x PZ2 - 2 x PZ3
3 x		5,5 - 6,5 - 8 mm
3 x		4 - 5 - 6 mm
15 x		2 x TB10 - 3x TB15 - 2x TB20 - 3x TB25 - 3x TB30 - 2 x TB40

911.2060 **230,-**











i  **32**
Další informace

TORION power



+30%



1 x		1/4"
1 x		1/4"
4 x		3 - 4 - 5 - 6 mm
4 x		PH1 - 2 x PH2 - PH3
4 x		PZ1 - 2 x PZ2 - PZ3
4 x		3 - 4 - 5 - 6 mm
7 x		T10 - T15 - T20 - T25 - T27 - T30 - T40
7 x		TB10 - TB15 - TB20 - TB25 - TB27 - TB30 - TB40









911.3030 **250,-**

i  **208**
Další informace



1000,-

1/4"		1/4": 205 mm
138 x		25 mm
29 x		50 mm
18 x		75 mm
20 x		4 - 5 - 6 - 7 - 8 - 9 - 10 - 11 - 12 - 13 mm 5/32" - 3/16" - 7/32" - 1/4" - 9/32" - 5/16" - 11/32" - 3/8" - 7/16" - 1/2"
1 x		1/4": 50 mm
1 x		1/4"

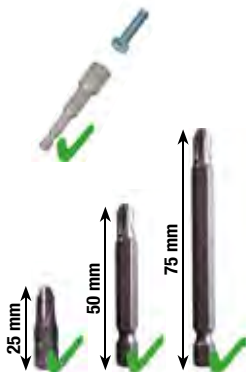

911.2008 **1/4"**

i **1**
Další informace

NEBO

2V1

230,-

1/4"

514.1126

85 mm

i **1**
Další informace

S KLOUBEM

280,-

1/4"

514.1136

90 mm

20°

i **27**
Další informace

LED

1/4"

eMONSTER

JEDNOU OKUSÍTE A NEBUDETE CHTÍT JINAK.

880,-

515.3600

max 6 Nm

max 4 Nm

max 2 Nm

4 x		3,0 - 4,0 - 5,0 - 6,0 mm
4 x		3,0 - 4,0 - 5,0 - 6,0 mm
5 x		PH0 - PH1 - PH2 - PH3
4 x		P20 - PZ1 - PZ2 - PZ3
4 x		T10 - T15 - T20 - T25
4 x		#0 - #1 - #2 - #3
1 x		PH1
1 x		50 mm
1 x		Max. 6 Nm

3,6 V

1.500 mAh

300 rpm

USB-C

2 x LED

TRANSFORMÁTOR MEZI ŠROUBOVÁKY



eMONSTER

Vysoký točivý moment
210 ot./min.
– to znamená
5x rychlejší
oproti ručnímu
utahování

Praktický ukazatel stavu
nabití baterie se 3 LED
kontrolkami

Vyztužená
převodovka



Zařízení 2v1 s dokonalou rovnováhou mezi výkonem a velikostí,
ideální pro práci nad hlavou a na stísněných místech.

Magnetické
upnutí bitu



Předvolba točivého momentu s
nastavením v 10 stupních



Funkce automatického zablokování
motoru při překročení točivého
momentu zamezí přetažení šroubu.

Integrované osvětlení



Ještě komfortnější
rukojeť



Akumulátor 1,3 Ah
s kapacitou na více
než

1 000
šroubů

Výkonný Li-Ion
akumulátor můžete díky
přípojce typu USB-C
snadno nabít, takže
bude zanedlouho znovu
připraven k použití.



3,6 V	1,500 mAh	210 rpm	USB-C	1 x LED

27
Další informace



Včetně
25
bitů

1000,-

515.6500



51



Další informace

UNIVERZÁLNÍ POMOČNÍK



1 Vrtání



2 Čištění



3 Broušení



23x



Ø 20 mm

4 Gravírování



5 Řezání



6 Leštění



Politura

Souprava akumulátorového multifunkčního nářadí, s 50 ks příslušenství eMONSTER



eMONSTER

1250,-

515.3990



50



Další informace

K DOKOUPENÍ



Souprava příslušenství, 50dílná

250,-

515.3992

i  **5**
Další informace

ERGOTORQUE plus

250,-

159.0005  



PH1
PH2
6,5 mm
5,5 mm
4 mm

i  **39**
Další informace

	50 mm
	3 - 4 - 5,5 - 6 - 6,5 - 8 - 10 mm
	PH0 - PH1 - PH2 - PH3
	PZ0 - PZ1 - PZ2 - PZ3
	2 - 2,5 - 3 - 4 - 5 - 6 - 8 mm
	T10 - T15 - T20 - T25 - T27 - T30 - T40
	TB10 - TB15 - TB20 - TB25 - TB27 - TB30 - TB40

ERGOTORQUE plus

1280,-

159.0100



i  **13**
Další informace

ERGOTORQUE plus





5 x		3,5 - 5,5 - 7 - 8 - 10 mm
5 x		PH0 - PH1 - PH2 - PH3 - PH4
1 x		6 mm
1 x		PH2
1 x		1/4"

1/4"

1700,-

151.1150

i  **13**
Další informace

12 IN ONE







380,-

240 mm



Šroubovák na bity s řehačkou, 12v1

159.2035    

MÁME KOMPLETNÍ SORTIMENT NÝTŮ!

A

i  **13**
 Další informace



A

580,-

150.9605

B

i  **12**
 Další informace



B

1250,-

150.9850

C

i  **12**
 Další informace



C

1500,-

150.9820

360°
otočný

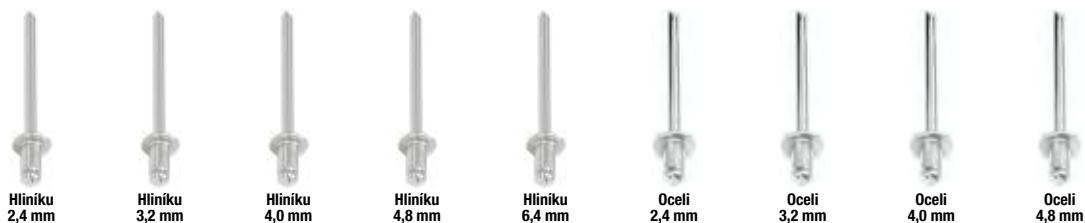

		Hliníku 2,4 mm	Hliníku 3,2 mm	Hliníku 4,0 mm	Hliníku 4,8 mm	Hliníku 6,4 mm	Oceli 2,4 mm	Oceli 3,2 mm	Oceli 4,0 mm	Oceli 4,8 mm
A	150.9605	✓	✓	✓	✓	✗	✓	✓	✓	✓
B	150.9850	✓	✓	✓	✓	✗	✓	✓	✓	✓
C	150.9820	✓	✓	✓	✓	✗	✓	✓	✓	✓
D	150.9805	✓	✓	✓	✓	✓	✓	✓	✓	✓
E	150.9625	✓	✓	✓	✓	✓	✓	✓	✓	✓
F	150.9630	✓	✓	✓	✓	✓	✓	✓	✓	✓

i **15** **D**
 Další informace



D

1700,-

150.9805

i **13** **E**
 Další informace



E

700,-

150.9625

i **17** **F**
 Další informace



F

4380,-

150.9630

3 x
8,5 x 5,5 - 17 x 12 - 19 x 15 mm

5 x
M4 - M5 - M6 - M8 - M10

6 mm



M3 M4 M5 M6 M8 M10



jedno nebo dvě
ruční ovládání

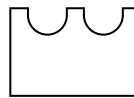

posuvné nůžky na
plech



délka
mm



otočná
hlava



v
kufříku

M3	M4	M5	M6	M8	M10	jedno nebo dvě ruční ovládání	posuvné nůžky na plech	délka mm	otočná hlava	v kufříku
X	X	X	X	X	X		X	210	X	X
✓	✓	✓	✓	X	X		✓	230	X	✓
✓	✓	✓	✓	X	X		✓	260	✓	✓
✓	✓	✓	✓	✓	✓		✓	260	X	✓
X	X	X	X	X	X		X	330	X	X
✓	✓	✓	✓	✓	✓		X	510	X	✓

i   **Další informace**



od 280,-

115.2011	175 mm	7"	280,- CZK
115.2010	240 mm	10"	330,- CZK
115.2012	300 mm	12"	400,- CZK
115.2016	415 mm	16"	800,- CZK







i   **Další informace**

STRANOVÉ ŠTÍPACÍ KLEŠTĚ, KTERÉ NEZKLAMOU



-64 HRC



Ø max. 5 mm

8" / 215 mm

430,-

119.0005



i   **Další informace**



2780,-

19 - 60 mm

165 mm

119.2055

CrV	DIN 5254 A	DIN 5254 B	DIN 5256 C	DIN 5256 D
-----	------------	------------	------------	------------

i   **Další informace**

3130,-

40 - 100 mm

230 mm

119.2060



i   **Další informace**

BEZPEČNOST NA PRVNÍM MÍSTĚ



60 - 100 mm



40 - 85 mm

1250,-



0° 15° 45° 90°

90° 45° 15° 0°

500.1350 **Souprava kleští na pojistné kroužky s řehačkovou funkcí**



Další informace

PODÍVEJ SE MI DO OČÍ, DRAHOUŠKU!



Další informace

630,-

Souprava nářadí na jemnou mechaniku



2500,-



1 x		120 mm	1 x		160 mm
1 x		120 mm	3 x		PH00 - PH0 - PH1
1 x		120 mm	3 x		2,0 - 2,4 - 3,0 mm

500.7220



2 x		125 - 130 mm
1 x		100 mm
1 x		100 mm
1 x		125 mm
1 x		150 mm
1 x		145 mm

500.7190



Další informace



s pevným hrotem pro nastavení ve tvaru rýsovací jehly

S PEVNOU MAGNETICKOU HLAVOU

150 - 675 mm

Ø 8,0 mm

150,-

Teleskopický magnetický držák 2v1, s nástrojem pro čištění a seřízení ostříkovačích trysek

550.1001



Další informace



s tenkým čistícím kolíkem

S FLEXIBILNÍ MAGNETICKOU HLAVOU

150 - 590 mm

Ø 11,0 mm

200,-

550.1023



Další informace



250,-

+

50 x 80 mm

285 - 875 mm

LED

Flexibilní inspekční zrcátko s osvětlením

550.1136

i **4**
Další informace

250,-

550.1045

i **9**
Další informace

500,-

550.1070

i **1**
Další informace

Piezo

115 mm

230,-

960.1110

i **11**
Další informace

Piezo

Mikrosouprava k pájení

750,-

960.1160

200 mm

20 mm 33 mm 1,6 mm 3,5 mm 4,5 mm 5 mm 30 mm

95 mm 95 mm

Ø 40 mm

i **5**
Další informace

Regulace teploty:
1≈50°C / 2≈100°C / 3≈200°C /
4≈350°C / 5≈550°C / 6≈650°C

260 mm

1 2 3 4 5 6

1 max. 450°C
2 max. 650°C

1 2 3 4

Oblasti použití:
Odstranění barev, pájení trubek, smršťování PVC, svařování a ohýbání umělých hmot, vysoušení, roztavení, atd.

750,-

960.1190

i **1**
Další informace

IP 34

15 + 1 m

3x 1,5 mm²

230 V 50 Hz

1000/3000 W

10 A

180°

3380,-

150.4217

i **12**
Další informace

145 mm

- 5,0 x 1,0 mm
- 5,0 x 1,0 mm
- 3,0 mm
- 3,0 mm
- 5,0 mm
- 5,0 mm
- △ 3,0 mm
- △ 2,0 mm
- 2,0 mm
- △ 5,0 mm
- 5,0 mm
- 5,0 mm

250,-

140.3050

i **5**
Další informace

200 mm

750,-

140.3000



Další informace



K PRAKTICKY VŠESTRANNÉMU POUŽITÍ



- | №. | Popis |
|----|--------------------|
| 1 | Tlačítko napájení |
| 2 | Přepínač funkcí |
| 3 | Kapacitní spínač |
| 4 | Vypínač osvětlení |
| 5 | LCD displej |
| 6 | Oblast snímače NCV |
| 7 | Testovací vodiče |

1250,-

Symbol	popis
	DC napětí
	Střídavé napětí
	Indikátor automatického vypnutí
	Indikátor slabé baterie
	Diodový režim
	Průchod
	Kapacita
	Poměr měřiče výkonu
	Funkce uchování dat
V, mV	Jednotka napětí: volt, milivolt
mF, µF, nF	Jednotka kapacity
MΩ, KΩ, Ω	Jednotka odporu
NCV	Bezkontaktní indukce napětí
Live	Testování živých vedení
KHz, Hz	Jednotka frekvence
°C/°F	Celsia/Fahrenheita



- automatické rozpoznání střídavého napětí, stejnosměrného napětí, odporu
- kontrola kabelů pro vedení elektrického proudu
- bezkontaktní kontrola indukčního napětí
- velký 3,5" barevný LCD displej

- souprava měřících kabelů se zkušebními hroty (červený/černý)
- včetně Li-Ion akumulátoru 700 mAh
- včetně robustního ochranného pouzdra
- praktické přenosné pouzdro

150.1765



Další informace



VÝHODNÁ CENA

500,-



150.1495

i  **1**
Další informace

580,-

PŘESNÉ A KOMPAKTNÍ

- aretace momentu
- měřicí lišty s dílkou v mm a palcích
- s tabulkou závitů

300.0510



i  **1**
Další informace

630,-

PLNĚ DIGITÁLNÍ!

- se stavěcím šroubem a jemným nastavením válečkem
- k měření vnějších rozměrů, vnitřních rozměrů, schodů a hloubek

300.0532



i  **1**
Další informace

SOME LIKE IT HOT, SOME NOT!

Infračervený teploměr, -38 až 520° C

1250,-

150.3040



i  **4**
Další informace

1430,-

550.1290



Refraktometr – optický zkušební přístroj pro elektrolyty a mrazuvzdorné kapaliny

i  **4**
Další informace

1700,-

550.1285



Refraktometr – optické zařízení k testování elektrolytu, nemrazoucích kapalin a aditiv AdBlue®

i **4**
Další informace

500,-

11 x 115 mm
15 x 185 mm
18 x 320 mm
18 x 470 mm

911.8100 **Souprava páčidel**

i **4**
Další informace

900 mm
600 mm
0°
45°
75°
90°

4500,-

911.8410 **Souprava páčidel**

i **22**
Další informace

Souprava univerzálních hydraulických stahováků, 2+3 ramena

- nízké riziko sklouznutí díky automatickému uzavírání stahovacího ramene
- 8 variant stahováků
- mimořádně robustní vřeteno s indukčně tvrzeným závitem
- nízké nároky na silu
- speciální nástrojářská ocel

7630,-

700.1200

10t.

20 - 35 - 85 mm
235 mm
185 mm
10 t, AG 1.1/2" x 16G
225 mm
170 mm
120 mm
Ø max. 100 mm

i **25**
Další informace

PŘIJDE VŠEMU NA KLOUB!

Souprava k vytahování ze závitů

- bohatá výběrová souprava
- k odstranění ulomených závitových svorníků a šroubů
- bez poškození závitu
- pouze nepatrné rozšíření závitového svorníku díky speciálně profilovaným závitovým kolíkům

1000,-

Führungshülse drill guide	Hülse Innen- Ø mm guide	vorböhren Ø mm pre-drilling	aufbohren re-drilling	Stift pin	Art.Nr. No. Pin	Mutter D nut D	Art.Nr. nut D	Stift + Mutter pin + nut
150.0591	4,0 / 3,2	3,2	-	3,2	150.0521	SW 10	150.0511	150.0515
150.0592	4,8 / 3,2	3,2	-	3,2	150.0521	SW 10	150.0511	150.0515
150.0593	4,8 / 3,2	3,2	4,8	4,8	150.0522	SW 11	150.0512	150.0515
150.0594	4,8 / 3,2	3,2	4,8	4,8	150.0522	SW 11	150.0512	150.0515
150.0595	6,0 / 4,8	4,8	6,4	6,4	150.0523	SW 13	150.0513	150.0515
150.0596	7,0 / 4,8	4,8	6,4	6,4	150.0523	SW 13	150.0513	150.0515
150.0597	7,0 / 4,8	4,8	8,0	8,0	150.0524	SW 14	150.0514	150.0515
150.0598	7,0 / 4,8	4,8	8,7	8,7	150.0525	SW 17	150.0515	150.0515
150.0599	8,0 / 6,5	6,4	8,7	8,7	150.0525	SW 17	150.0515	150.0515
150.0610	8,5 / 6,5	6,4	8,7	8,7	150.0525	SW 17	150.0515	150.0515

150.1305 **M5 - M6 - M8 - M10 - M12 - M14 - M16**



Další informace

1250,-

Souprava vyťahováků na podpěrné čepy

- pohon vnějším šestihranem 21,0 mm
- s funkcí upnutí doprava a doleva
- spolehlivé uchopení třemi válečky
- zašroubování a vyšroubování bez nutnosti použití druhé kontramatice na čepu
- vhodné také pro nadměrně dlouhé podpěrné čepy – díky úplnému provrtání



M5 M6 M7 M8 M10 M12 M14

152.1101 M5 - M6 - M7 - M8 - M10 - M12 - M14



Další informace

NOŠENÍ JE JEHO KONÍČKEM!

630,-

EN388



4131X

Mikrojemné zapletení



	Velikost	Obsah
310.0490	7	12 párů
310.0491	8	12 párů
310.0470	9	12 párů
310.0475	10	12 párů
310.0480	11	12 párů



Další informace

100,-

CE
EN 166



310.0120



Další informace

FLAME DESIGN



1250,-

310.0155



Další informace

STEEL DESIGN



1250,-

310.0195



EN 379 1/1/1/2



EN 175

Technické údaje:

Výběr barvy:	plynulá regulace DIN 9 - 13
	Standardní nastavení světlosti: DIN 4
Přepínací reakční doba:	1 / 25 000 s
	Prodlouha 0,2-0,8 s (s možností nastavení)
UV / IR ochrana:	podle normy EN169 / do DIN 16
Provozní teplota:	-5°C až +55°C
Skladovací teplota:	-20°C až +70°C
Napájení proudem:	přes solární články
Výška:	220 mm
Šířka:	200 mm
Délka:	295 mm
Hmotnost:	480 g
Rozměry kazety:	110 x 90 x 9 mm
Průhledové okénko:	92 x 42 mm

i   **1**
Další informace

Univerzální rozprašovač s tlakovým čerpadlem

- vysoce kvalitní polyetylén
- Pro různé chemické látky, např. mycí prostředky, rozpouštědla nebo čisticí prostředky, atd.
- Není určeno pro čisticí přípravky na brzdy
- mosazná rozprašovací hlava s možností nastavení a uzavření
- vitonová těsnění
- vhodný pro práci dole hlavou



150.8251 1 L 380,- CZK
150.8252 2 L 500,- CZK

od 380,-

PE VITON

360°



i   **7**
Další informace

200,-

1 2 3 4 5 6

TiA 1040-02R TiA 1040-04R TiA 1040-10R
TiA 1040-12R TiA 1040-17R

FUGENFIX®

116.1050 **Souprava silikonové škrabky a stahováku FUGENFIX**

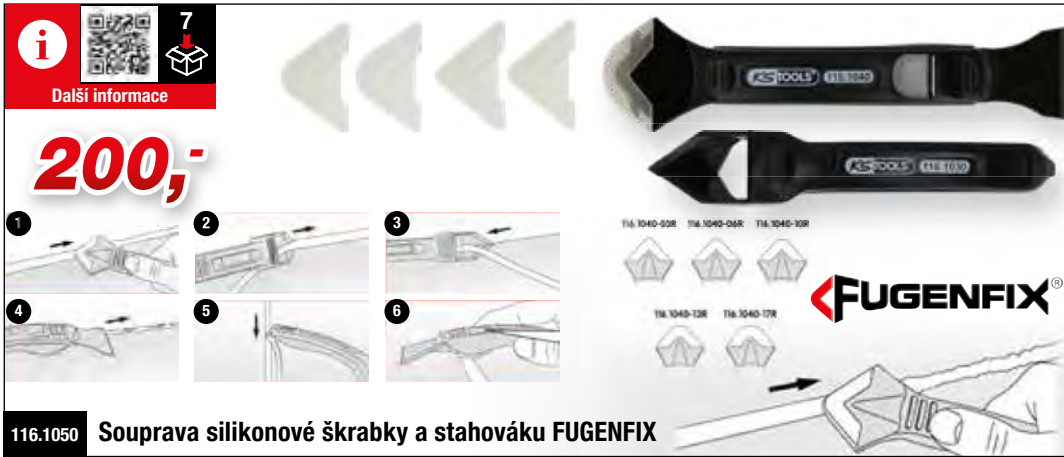

i   **2**
Další informace

1/2"

270 mm

90 mm

1" - 3/4" - 1/2" - 3/8"

500,-

Souprava univerzálních stupňovitých klíčů 3/8"-1"

130.3000 3/8" 1/2" 3/4" 1"



i   **1**
Další informace

1000,-

70 mm

12 - 35 mm

180 mm

12 - 35 MM

i   **1**
Další informace

3250,-

110 mm

28 - 67 mm

250 mm

28 - 67 MM

Ráčnový odřezávač trubek

104.5060 Inox Steel
104.5050 Inox Steel



i   **1**
Další informace

17 x / 2,5cm

8 x / 2,5cm

450,-

325 mm

907.2113 **Japonská dvouruční pila, s dvojítm ozubením**



i  **1**
Další informace



100,-

907.2240

i  **1**
Další informace



280,-

907.2105

i  **2**
Další informace

380,-





907.2172 **Souprava zavíracích nožů**

i  **3**
Další informace

1000,-



118.0050 **Souprava nůžek na stříhání plechu s páčkou**

i  **5**
Další informace

Souprava Wi-Fi videoskopu, s předním HD kamerovým snímačem Ø 5,5 mm, 0°

STEJNĚ CHYTRÝ JAKO VÁŠ TELEFON

HD

IP68

3500 mm







WiFi

1000,-

550.7560

VIDĚT TO, CO VIDĚT NENÍ

i **5**

Další informace

HD

6 mini LED svítílny s funkcí regulace jasu

Ø 6,0 mm

1000 mm

6000,-

0 / 90°

Magnet

0° 90°

550.7500 Souprava HD videoskopu, s předním HD kamerovým snímačem Ø 6,0 mm, 0° a 90°, funkce přepínání

BUĎ

EXTEND YOUR EYE

Pouzdro z nerezové ocele
Šroubovací přípojka pro příslušenství

Korunkový tvar (ochrana + optimální vyčištění)

Kamera
Čočka
LED
Pouzdro z nerezové oceli s vnějším závitem
Safírové sklo

1000 mm
50 mm

Přípojka pro sondu

3,5"

USB 2.0

microSD

1500 mAh Li-polymer

IP 67

1280 x 720

JPG

150 mm

-10°/+50°C

550.7530 Souprava HD videoskopu, s předním HD kamerovým snímačem Ø 4,5 mm, 0° a 90°, funkce přepínání

NEBO

i **7**

Další informace

HD

PUSH 0 / 90°

Ø 4,5 mm

6 mini LED svítílny s funkcí regulace jasu

1000 mm

7500,-

0 / 90°

Magnet

Háky

0° 90°

550.7530 Souprava HD videoskopu, s předním HD kamerovým snímačem Ø 4,5 mm, 0° a 90°, funkce přepínání



HORKÁ CENA, PEKELNĚ DOBRÝ VÝKON > 1.600 NM POUZE 1750 CZK



		MAX. Nm	U/min	m/s ²	dbA	dbA	l/min	PT			Kg
1	515.1315	1084	9000	<10,36	106,0	115,0	169	1/4"	—	✓	1,2
2	515.1270	1390	10.000	<9,18	102,0	113,0	135	1/4"	—	✓	1,3
3	515.1200	1600	8500	<17,5	89,9	100,9	169	1/4"	✓	—	2,1
4	515.1210	1690	7930	<17,9	87,0	98,0	178	1/4"	✓	—	2,1
5	515.3785	1690	7930	<13,56	88,0	104,0	178	1/4"	✓	—	2,2
6	515.3400	2000	8500	<17,25	91,0	100,9	196	1/4"	✓	—	2,2

**OBROVSKÁ
SÍLA ZA
NEJNIŽŠÍ
CENU!**

max.
**1.600
Nm**

1750,-



výkonné příklepové
ústrojí se dvěma
kladivky



JEN!
~2,1 KG



3.450 Nm



7 515.3250



21250,-

9 515.3270



22630,-



8 515.3260



21250,-

10 515.3280



22630,-



		MAX. Nm	U/min	m/s ²	dbA	dbA	l/min	PT			Kg	
7	515.3250	3/4"	3450	6200	<12,57	115,5	104,5	283	1/2"	✓	—	6,7
8	515.3260	3/4"	3450	6200	<12,88	115,5	104,5	283	1/2"	✓	✓	7,7
9	515.3270	1"	3450	6200	<12,57	115,5	104,5	283	1/2"	✓	—	6,7
10	515.3280	1"	3450	6200	<12,88	115,5	104,5	283	1/2"	✓	—	7,8

výkonné příklepové ústrojí se dvěma kladivky

výkonné příklepové kladivo Jumbo

Všechny ceny jsou uvedené v Kč bez DPH a platí do 30. 9. 2023



i 1
Další informace

od 630,-

PU ✓

515.3330	6,0 mm	G1/4" AG	8,0 m	630,- CZK
515.3335	8,0 mm	G1/4" AG	15,0 m	880,- CZK
515.3340	10,0 mm	G3/8" AG	15,0 m	1000,- CZK

i 1
Další informace

250,-

Pneumatická vyfukovací pistole s regulací průtoku

L1: 235,0 mm
L2: 100,0 mm
L3: 75,0 mm

515.1901

i 3
Další informace

500,-

TROJKA Z MÍSTA, KDE TO FOUKÁ

515.1921 **Souprava pneumatické vyfukovací pistole**

510 mm
330 mm
95 mm

i 1
Další informace

3000,-

15 m

Technické údaje:
Vnitřní průměr hadice: 10,0 mm
max. tlak: 20,0 bar
Spojovací závit: 1/4"

Ø 10 MM X 15 M

i 1
Další informace

4500,-

1,5 m

Technické údaje:
Vnitřní průměr hadice: 13,0 mm
max. tlak: 20,0 bar
Spojovací závit: 3/8"

Ø 13 MM X 15 M

515.3440 **Automatické navíjecí zařízení vzduchotlakých hadic** **515.3445**

i **1**
Další informace



480 mm
320 mm
36 mm

300,-

500.8040



i **1**
Další informace



1.150 mm
550 mm
36 mm

1000,-

500.8045



i **1**
Další informace



360 mm
365 mm
360 mm

1

1250,-

500.8020



i **1**
Další informace



400 - 540 mm

2

1700,-

500.8030

i **1**
Další informace



490 mm
1.040 mm
85 mm

3

1750,-

500.8011



i **1**
Další informace



1.200 mm
420 mm
145 mm

4

2500,-

500.8000



	1	2	3	4	5
Technické údaje:	500.8020	500.8030	500.8011	500.8090	500.8000
Barva	červená	červená	červená	červená	červená
materiál	Ocelová trubka	Kov	Kov	umělá hmota	Kov
Počet říditelných koleček	4	5	6	6	6
pojistné	✓	✓	✓	✓	✓
Typ pneumatiky	Umělá hmota	Umělá hmota	Umělá hmota	Umělá hmota	Umělá hmota
vycpáno	✓	✓	✓	✗	✓
s možností výškového nastavení	✗	✓	✓	✗	✓
Obsah balení	1	1	1	1	1
Celková délka L v mm	365,0 mm	370,0 mm	1040,0 mm	1030,0 mm	1200,0 mm
Šířka Š	360,0 mm	370,0 mm	490,0 mm	480,0 mm	420,0 mm
Výška V	360,0 mm	420,0 - 540,0 mm	85,0 - 400,0 mm	115,0 mm	145,0 - 510,0 mm
Celková nosnost kg	90 kg	90 kg	90 kg	120 kg	90 kg

i **1**
Další informace

NEJLEHČÍ



1.030 mm
480 mm
115 mm

5

1700,-

500.8090





Další informace

- profil z rýhovaného plechu na schodech
- bez rizika převrácení díky na šikmo postaveným opěrným nohám
- sklápěcí provedení pro úsporu místa při skladování

1380,-



800.0965 Štafle s hliníkovými příčkami

TESTOVÁNO



PRO VAŠI BEZPEČNOST!



Další informace

- neklouzává profil na povrchu plošiny
- s velkou plošinou pro bezpečnou práci
- umělohmotné hrany na nohách pro ochranu plošiny a podlahy

2500,-



800.0960 Bezpečnostní hliníková plošina



Další informace

MALÝ A VELKÝ ZÁROVEŇ!



4500,-



500.8100 Univerzální teleskopický vozík k víceúčelovému použití, s kolečky

i **1**

Další informace

max. 8 bar
(116 PSI)

60° C
140° F

500,-

KSTOOLS
1,5L

1

2

Water
Max. 40° C

Detergent
Max.

3

4

5

Switch

Lock

150.8271

Pěnový rozprašovač s tlakovým čerpadlem (pěnič)

i **1**

Další informace

2130,-

350 mm

650 mm

www.kstools.com
KSTOOLS
500.8013

- robustní pojízdná stolička
- omývatelný polstrovaný potah
- čtyři říditelná kolečka z polyvinylchloridu s kuličkovými ložisky
- maximální zatížení 95 kg
- pevná ocelová konstrukce z čtyřhranných trubek
- s odkládací plochou k odkládání nářadí a menších dílů

500.8013

Pojízdná stolička

i 1
Další informace

Ø 90 mm 15 mm M8

150,-

515.1243 **Sěrka na fólie**

i 1
Další informace

Ø 100 mm 24 mm M8

400,-

515.1247 **Sěrka na fólie s lamelami**

i 6
Další informace

SADA = 6x

750,-

515.1285

i 6
Další informace

SADA = 6x

2250,-

515.1366

i 1
Další informace

ON - OFF

3550,-

515.1980 **Pneumatická čistící pistole**

1/4" NPT	8000	160 Litre
6,3 bar (Popul)	3/8"-10 mm	<3,90 m/s
106 dBA	95 dBA	1000 ml

VOLITELNĚ

i 1
Další informace

150,-

515.1983 **Kartáčový nástavec**

i 1
Další informace

150,-

515.1986 **Kartáčový štětec**

i **1**

Další informace

6,3 Bar 96 Liter

92 dBA 1/4" BT

K odsávání nečistot do prachového pytle namísto sfoukávání z povrchu

1000,-

515.5090 **Pneumatická sací pistole**

i **6**

Další informace

750,-

140.2370 **Souprava k uvolnění svorek**

i **11**

Další informace

500,-

911.8205 **Souprava umělohmotných klínů MASTER**

i **1**

Další informace

DC 12V 24V AC 100-240V 50/60 Hz

- odstranění zápachu a dezinfekce interiéru vozidla
- automatické vypnutí v režimu odstraňování zápachu po uplynutí 60 minut
- bez chemických přísad – garance vyčištění bez reziduí
- bez stop po čištění na citlivých plochách
- odstranění plísně, bakterií, hub a roztočů

2000,-

550.1183 **Plasmový čistič vzduchu s ionizační technikou**

i 7
Další informace

2
Ø 0 - 65 mm

3
Ø 0 - 30 mm

4
Ø 0 - 38 mm

5
Ø 0 - 48,5 mm

6
Ø 0 - 45 mm

7
Ø 0 - 45 mm

1
Ø 0 - 60 mm

2000,-

115.1055 **Souprava kleští na hadicové spony motorových vozidel**

i 3
Další informace

250,-

Ø 15 mm
150 mm

Ø 30 mm
180 mm

Ø 60 mm
250 mm

115.5050

i 3
Další informace

Ø 15 mm
155 mm

Ø 35 mm
255 mm

Ø 23 mm
165 mm

330,-

115.5055

i 1
Další informace

380,-

150.9221 **Odsávací a plnicí ruční pumpe**

i 1
Další informace

500,-

100 mm

150.2519 **Speciální nástrčný klíč 3/8" na šroubová spojení sacích potrubí**

i 1
Další informace

500,-

120 V

150.2820 **Elektrická pumpe k odsávání a plnění oleje**

12V 5A 60W
Richtung Direction
150.2820

PETROL **DIESEL** **OIL**



Další informace



0 - 2,5 bar



max. 76 cm

0 - 200 °C
0 - 400 °F

1600 mm



R123
R124

R123
R125

#1

#2

#3

M50 x 2,5

M42 x 3



M58 x 3

M62 x 3

M48 x 4

M45 x 3

M50 x 2,5

M60 x 4

M52 x 3



M48 x 2,5

M42 x 2,5

M50 x 3

M46 x 3

M34 x 2,5

75 mm



4500,-

Souprava nástrojů pro servisní diagnostiku chladicího systému MASTER

150.1930



Další informace

250 ml



VOLITELNĚ

380,-

150.1914

2500,-

150.1910

Souprava k testování netěsnosti hlavy válců, únik CO2

i  **1**
Další informace

500,-



1 **2**

500.7505 **Stahovák zapalovacích cívek, na tyčové zapalovací svíčky**



i  **7**
Další informace

PRO MOTORY VAG A OPEL

1750,-



1 **2** **3** **4** **5** **6** **7**

500.7570 **Souprava stahováků zapalovacích cívek s T rukojetí, pro motory VAG a Opel**







i  **7**
Další informace

120 ml 120 ml



6x10
6x6
6x8
6x4
600 mm
Ø 6x9 mm

4250,-

Souprava tlakové a podtlakové pumpy

150.1900



i  **24**
Další informace



1250,-

Souprava univerzálního nářadí k montáži těsnících kroužků hřídelí a simmeringů

700.1280



i  **1**
Další informace



max. 165 mm

1000,-



**Univerzální stahovák drážkovaných řemenic,
Ø 40-165 mm**

150.3170



i  **1**
Další informace

Oblasti použití:
Citroën, Peugeot, Opel a Toyotase zážehovým motorem 1,0 a 1,2
(kódy motoru: ZM2 (E80F / E80) / HM01 (1PP) / HMV, HMZ (E82)
/ HMZ (E82 / E82F) / HMT (E82D) / HMU (E82D) / HMZ (E82D)
/ HNY (E82DTS) / HMV (E82M) / HMY (E82M) / B12XE (E82F)
/ D12XE (E82FA) / B12XHL (E82DT) / D12XHL, F12XHL (E82ADT) /
B12XHT (E82DTS) / D12XHT, F12XHT (E82ADTS)

250,-



400.2118 Zkušební nářadí na ozubené řemeny, pro vozidla PSA

i  **1**
Další informace



880,-

150.3130 Univerzální stahovák řemenic, tříramenný

i  **22**
Další informace

1250,-

- k montáži a demontáži obtížně rozpojitelných spojovacích zásuvek pružinových uzávěrů CLIC u palivového vedení, vedení klimatizací, vzduchových vedení a hydraulického vedení
- bez poškození zásuvných spojek, palivového vedení a palivových hadiček
- rychlé a snadné rozpojení palivového vedení
- pro téměř všechny spojovací zásuvky u evropských, asijských a amerických vozidel









5/16" 1/4" 5/16" 3/8" 3/8" 1/2" 5/8" 7/8"

3/8" 1/2" 5/8" 3/4" 5/16"

3/8" 1/2" 5/8"

3/4" 7/8" 5/16" x 3/8"

5/16"

115.1260 Souprava k uvolnění kabelovým spojek

i  **1**
Další informace

• TESLA Model 3 a Model S

150,-

EPR10

1/4"

911.4363  **1/4"** **Nástrčný ořech se speciálním profilem, pro vozidla Tesla**



i  **1**
Další informace

130,-

6-24V **125 mm**

550.1504 **Zkušební lampa 6 - 24 V**





i  **2**
Další informace

- ideální zkušební lampa s mnoha zkušebními funkcemi
- s integrovaným osvětlením pro optimální osvětlení zkoušeného místa
- s výměnným zkušebním hrotem pro optimální rozšíření o běžně prodávané zkušební a testovací komponenty
- rychlá kontrola funkce bez demontáže komponent
- integrovaná bimetalová zkratová ochrana (7,5 A) – bez opotřebování pojistky při vyhledávání poruch

25 m

3250,-

Funkční zkušební lampa 6 - 24 VDC s kabelem 25 m

150.1655



i  **2**
Další informace

1 Příjimač

2 Vysílač s krokodýlkovými svorkami

- k rychlému, jednoduchému a odbornému vyhledání zkratů, defektů na kabelech a povrchového proudu bez nutnosti propíchnutí vodiče
- velká úspora času – odstranění obložení, koberců a lišt ve vozidle se omezuje jen na to nejnnutnější
- k testování a vyhledání spojů s občasným výpadkem („uvolněných kontaktů“)
- vysílač se izolovanými krokodýlkovými svorkami přes pojistkovou skříň připojí ke kontrolovanému elektrickému obvodu

1500,-

150.3075 **Čidlo elektrického zkratu**







Další informace



Pro téměř všechny baterie

S tiskárnou a 3 cívkami papíru



DŮKLADNÉ PROVĚŘENÍ STAVU BATERIE

Digitální zkoušečka baterií a nabíjecích systémů 12 V / 24 V, s integrovanou tiskárnou

550.1649



9200,-

Technické údaje:

Zobrazení:	digitální
Pracovní oblast CA / MCA:	40-2.000 CCA
Pracovní oblast CCA:	40-2.000 CCA
Pracovní oblast DIN:	40-2.000 CCA
Pracovní oblast EN:	40-2.000 CCA
Pracovní oblast IEC:	40-2.000 CCA
Pracovní oblast JIS#:	40-2.000 CCA
Pracovní oblast SAE:	40-2.000 CCA
Provozní teplota:	0°C až +55°C
Frekvenční rozsah:	100 Hz
Rozsah měření:	9-36 V
Přesnost měření:	+/- 0,5 Megaohm
Rozsah napětí:	9-36 V



Další informace



15300,-

- ideální pro zážehové a vznětové motory v osobních automobilech a dodávkách
- plně izolované bateriové svorky (1 000 A)
- zvuková výstraha při změně polaritu
- bezproudové připojení kabelu k baterii vozidla
- pouzdro odolné proti úderům s pogumovanou odkládací plochou

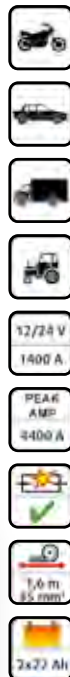

550.1720 12V + 24V bateriový booster - mobilní pomocné startovací zařízení 1400 A

SAFETY Xtreme





26

Další informace



1000 V





2 x		4 mm - 5,5 mm
2 x		PH1 - PH2
6 x		6 - 8 - 10 - 12 - 13 - 17 mm
1 x		185 mm
1 x		165 mm
1 x		3/8"
1 x		3/8": 200 mm
1 x		3/8": 125 mm
10 x		3/8": 8 - 10 - 11 - 12 - 13 - 14 - 16 - 17 - 19 - 22 mm
1 x		200 mm

8250,-

3/8"

117.1895

Souprava izolovaného nářadí na vozidla s hybridním a elektrickým pohonem





43

Další informace



1000 V













14130,-

3/8"

117.1890

Souprava izolovaného nářadí na vozidla s hybridním a elektrickým pohonem

4 x		2,5 - 3 - 3,5 - 4 mm
3 x		PH1 - PH2 - PH3
3 x		T20 - T25 - T30
1 x		210 mm
1 x		185 mm
1 x		165 mm
1 x		215 mm
1 x		165 mm
1 x		240 mm
2 x		10 - 25 mm
1 x		180 mm
1 x		3/8"
15 x		3/8": 6 - 7 - 8 - 9 - 10 - 11 - 12 - 13 - 14 - 16 - 17 - 18 - 19 - 20 - 22 mm
2 x		3/8": 150 - 250 mm
3 x		3/8": M8 - M10 - M12
1 x		Ø 200 mm
1 x		200 mm
1 x		500 m





18

Další informace



1000 V







8250,-

118.1500

Souprava plochých klíčů s ochrannou izolací

18 x		7 - 8 - 9 - 10 - 11 - 12 - 13 - 14 - 15 - 16 - 17 - 18 - 19 - 20 - 21 - 22 - 23 - 24 mm
------	---	---





1

Další informace

<44.500 V







4500,-

150.0913

Izolovaná tyč pro záchranné práce



ZÁKLADNÍ SOUPRAVA PRO ELEKTROMOBILITU

ecoline



1

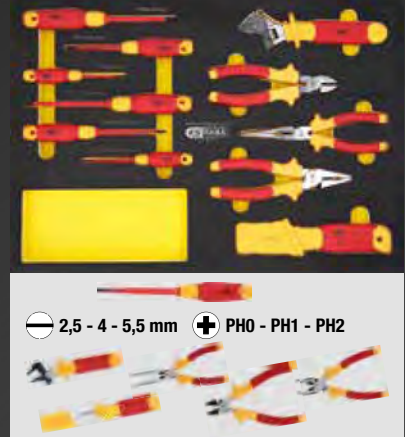

2,5 - 4 - 5,5 mm PH0 - PH1 - PH2

2

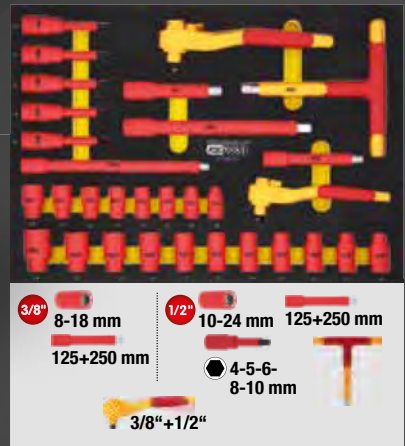

3/8" 8-18 mm 125+250 mm
1/2" 10-24 mm 125+250 mm
4-5-6-8-10 mm
3/8"+1/2"

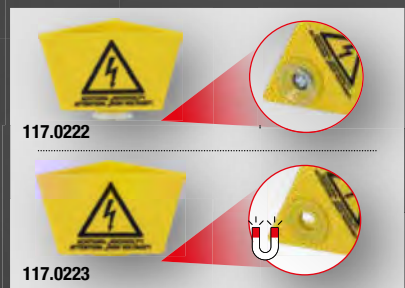

117.0222

117.0223



Čtvercové otvory pro příslušenství

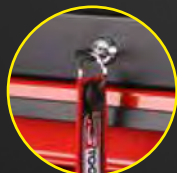

uzavírání s integrovaným válcovým zámekem



pracovní deska s vložkou z pěnové hmoty o tloušťce 10 mm



S automatickým zasunutím a funkcí SOFT-CLOSE

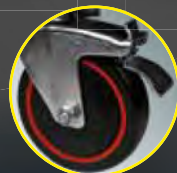

2 x s pohyblivou a otočnou brzdou, Ø kol: 125 mm

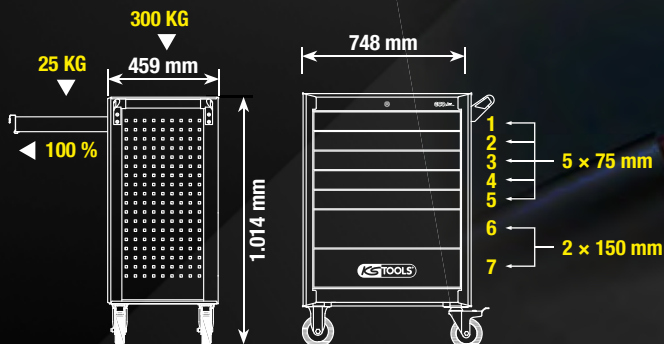

Dílenský vozík ECOline se 42 ks izolovaného nářadí na hybridní vozidla a elektromobily

32480,-
Včetně 42 kusů nářadí

117.6144



Další informace

performance plus **e10**



107480,-



Výstražný symbol – blesk

917.3898



Výstražný symbol – vypínač

917.3897



Izolovaná pochozí rohož, 1 000 mm

117.3819



Spodní rukavice

117.1660



Ochranné rukavice pro elektroinstalatéry s ochrannou izolací, velikost 10, tloušťka 1, bílá

117.1664



Ochranný obličejový štít pro elektroinstalatéry, třída 2

117.1796



117.6172 Souprava izolovaných nástrojných ořechů 3/8" +1/2", s momentovým klíčem, ve vložce z pěnové hmoty, 72dílná



117.6133 Souprava izolovaných klíčů ve vložce z pěnové hmoty, 33dílná



117.6121 Souprava šroubováků ve vložce z pěnové hmoty ERGOTORQUE VDE, 21dílná



117.6117 Souprava kleští ERGOTORQUE VDE ve vložce z pěnové hmoty, 17dílná

250,-



117.0223

Stojánek ve tvaru střechy, se symbolem blesku a magnetem

NEJOBŠÁHLEJŠÍ VE SVÉ TRÍDĚ

117.6155

Dílenský vozík PERFORMANCEplus e10 se 164 ks izolovaného nářadí na hybridní vozidla a elektromobily

250,-

117.0222

Stojánek ve tvaru střechy, se symbolem blesku a přísavkou



380,-

117.0226

Stojánek se symbolem blesku

1750,-

117.1550

Souprava uzávíracích sloupků s řetězem

2x

3500,-

117.1545

2 x Nůžková zábrana z plastu



Katalog elektromobility se 188 stranami naleznete na webové stránce www.kstools.com

i  **4**
Další informace

Ø 22,0 - 28,0 mm

Ø 15,0 - 21,0 mm

Ø 17,0 - 25,0 mm

Souprava centrovacího nářadí na spojky

230,-

150.2180 Ø 15,0 - 28,0 mm



i  **11**
Další informace

150 kg

310 mm

450 mm

300 mm

9880,-

160.0910 **Souprava univerzálních držáků na převodovky**



i  **3**
Další informace

- 1 Namontujte a demontujte plničku A
- 2 Vypusťte olej nízkým průtokem
- 3 Zkontrolujte hladinu oleje
- 4 Vypusťte olej plným průtokem

630,-

9G-TRONIC

56 mm

20 mm

74,5 mm

9 mm

28,5 mm

39,5 mm

9 mm

152 mm

48 mm

150.9695



160.0910 **Souprava univerzálních držáků na převodovky**



i  **24**
Další informace

NEJOBŠÁHLEJŠÍ!

5000,-

Včetně 23dílné soupravy adaptérů

NO VIN KA

150.9261 1/8-27 NPT Ford

150.9262 BMW, Honda, Nissan etc.

150.9263 VAG

150.9264 VAG, Porsche

150.9265 M10 x 1.0 VAG, Mini Cooper

150.9267 M12 x 1.5 Mercedes

150.9268 M24 x 1.5 VAG DSG

150.9269 M22 x 1.5 VAG CVT

150.9271 M18 x 1.5 Skoda

150.9272 M30 x 1.5 VAG, Skoda

150.9273 Universal Flexible 300 mm, Honda, Hyundai, Kia, etc.

150.9274 5/16-24 (UNF) Volvo

150.9276 M18 x 1,5 Toyota / Lexus

150.9277 M8 x 1,0 Nissan / Infinity

150.9278 ATF-Adapter V.W, Passat

150.9562 Nissan Juke M12 x 1,25

150.9563 Mini Cooper M14 x 1,5

150.9564 Nissan M10 x 1,5

150.9566 GM M12 x 1,75

150.9567 Mercedes 725-9G

150.9102 VAG 7 DSG

150.9103 VAG 7 DSG

150.9104 VAG 7 DSG

150.9105 **Souprava univerzálního systému pro plnění převodového oleje, s 23dílnou soupravou adaptérů**



i  **4**
Další informace



2800,-

160.0195 McPherson podpěra vzpěry pro zvedák převodovky

i  **7**
Další informace



2500,-

150.9545 Speciální souprava pomůcek k montáži tlumičů nárazů, pro tlumiče s vratnou ochrannou pružinou

i  **6**
Další informace

NA TĚMĚŘ VŠECHNY PRUŽINY!



11300,-

500.8400 Souprava univerzálních napínáků pružin

- ideálně vhodná ke spolehlivé montáži a demontáži vzpěr McPherson
- nezbytné nářadí pro výměnu tlumičů nebo spirálových pružin
- univerzální nářadí na 90 % běžných pružin v osobních vozech a dodávkách
- cenově dostupná a spolehlivá alternativa k běžným napínákům pružin
- vhodné také na konické a kuželové pružiny
- s TÜV certifikátem

26000 N

Ø 140 - 195 mm

Ø 80 - 160 mm

Technické údaje:

Kapacita pružiny:	2600 kg
Upínací rozměr, max.:	355,0
Maximální tlak pružiny:	80,0 - 195,0 mm

TESTOVÁNO



PRO VAŠI BEZPEČNOST!

i **11**
 Další informace

TUV SUD
 Safety tested Production monitored
 tuv-sud.com/ps-cert

1/2" x 1/2", 100 Nm
 Ø 30 mm

Ø 90 - 140 mm

9330,-

500.8765 Souprava teleskopického středového klíče na vnitřní pružiny, Audi a Seat

K ROZŠÍŘENÍ

i **2**
 Další informace

Ø 95-110 mm **2500,-** v kombinaci s napínákem pružin 500.8755 + 500.8765

NOVINKA

• Oblasti použití:
 Mercedes třídy E (W211 / W212), třídy C (W204), GLA (X156), GLK (X204), Ford Focus II (MK2), BMW řady 1 (E81), Volkswagen Passat (B8 / 3G)

500.8770 Párový držák pružiny, Ø 95-110 mm

K ROZŠÍŘENÍ

i **9**
 Další informace

TUV SUD
 Safety tested Production monitored

Ø 30 mm

Ø 90 - 140 mm Ø 75 - 115 mm

8480,-

500.8755 Souprava univerzálního teleskopického středového klíče na vnitřní pružiny

WARNING - ACHTUNG - ADVARSEL
 ADVERTENCIA - AVERTISSEMENT

PRO 95 % VŠECH VOZIDEL



Další informace

max
12000
N



28730,-

Pneumatický napínák pružin se stojanem, max. 10 bar

500.8800

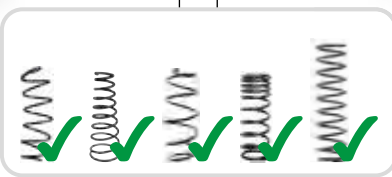

Další informace

max
24000
N

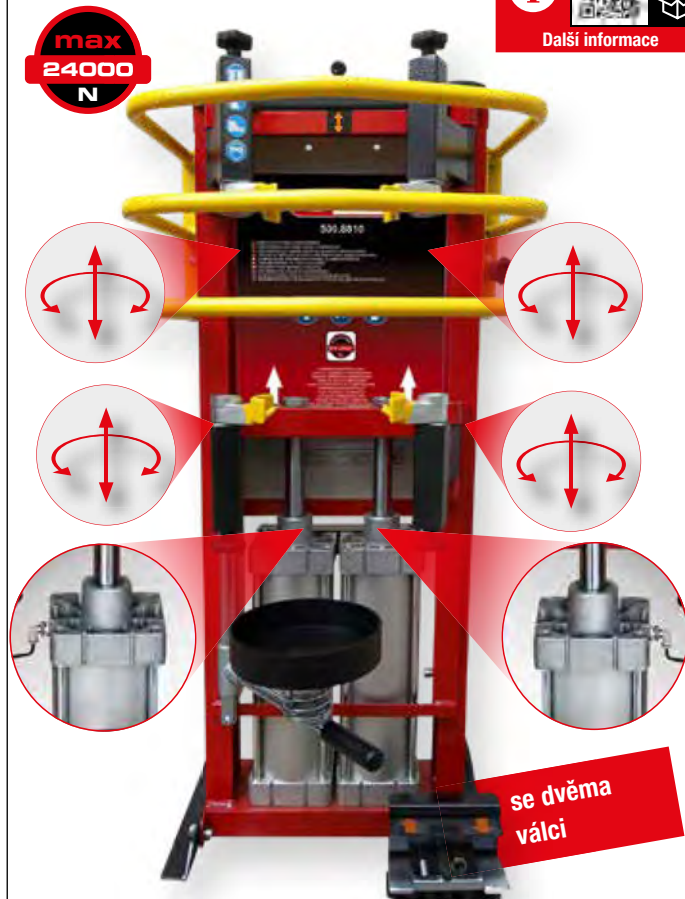

se dvěma válci

39980,-

Pneumatický stojanový stlačovač pružin se dvěma válci

500.8810



Další informace

- snadná manipulace
- speciální nástrojářská ocel
- ideální k upnutí vzpěr
- optimálně vhodné pro dobrou stabilitu při montáži a demontáži
- čtyři upínací svorníky a čtyři závitové svorníky
- dodávka včetně dvou rozpěrnými kroužky k montáži



7050,-

Adaptérový kotouč pro pneumatický napínák pružin se stojanem

500.8801

SOUPRAVA NAPÍNÁKŮ PRUŽIN, VČETNĚ ADAPTÉROVÉ DESKY



Další informace

33730,-

Pneumatický stojanový napínák pružin, včetně adaptérové desky

500.8805



Další informace

44980,-

Pneumatický stojanový stlačovač pružin se dvěma válci, včetně adaptérové desky

500.8815



i   1
Další informace

max. 8,0 bar

1/4" PT

450 mm

2500,-

**Na univerzální
nápravové manžety**

515.3100 Pneumatický montážní přístroj na těsnící manžety náprav



i   1
Další informace

100 mm

255 mm

Ø 30 mm

1250,-

150.1850 Univerzální stahovák na kloubové hřídele



i   1
Další informace

0 - 45 mm

270 mm

1000,-

**Kleště na hadicové svorky pro
utahení utahovacím momentem**

115.1056



i   1
Další informace

max. 12 mm

1250,-

**Upínací kleště pro
stahovací pásky s kulatým
uzávěrem, jakostní ocel**

115.1590

+ od 650,-

Stahovací pásek s kulatým
uzávěrem, jakostní ocel

200 - 350 mm

115.1591		 100	4,6 × 200 mm	650,- CZK
115.1592		 100	4,6 × 250 mm	650,- CZK
115.1593		 100	4,6 × 350 mm	730,- CZK
115.1594		 100	4,6 × 500 mm	950,- CZK



i   **1**
Další informace

UNIVERSAL

10 mm

1000,-

700.5662 Rozpínací nářadí na stahovací otvory



i   **1**
Další informace

630,-

1/2" 30 mm

150.1721 Mercedes W167, W205, W213, W238, W253, W25

Speciální nástřný ořech na nosné klouby, pro vozidla Mercedes



i   **6**
Další informace

9250,-

515.3880 Souprava pneumatického sekacího kladiva Vibro-Impact

VIPRO

110 mm

110 mm

130 mm

100 x 25 x 12 mm

31x / 1sec.



i   **3**
Další informace

800,-

700.5635 Souprava vyrážeců na upínací šrouby



i   **1**
Další informace

5150,-

150.1608 Nářadí k uvolnění spojovacích tyčí řízení Vibro-Impact

- uvolnění spojovacích tyčí řízení, šroubových kontraspojení nebo šroubových spojení v oblasti nápravy, atd., s použitím vibrací
- Speciální vibrační trn vystaví šroubové spojení, které se má uvolnit, úderovému impulsu, čímž se uvolní usazená rez a usnadní proces uvolnění
- adaptér pro pneumatický sekáč (10 mm) pro použití s běžně dostupnými pneumatickými sekacími kladivy

27 mm

290 mm

65 mm



i **1**
Další informace

600 - 915 mm

2250,-

911.8187 Teleskopické páčidlo s přestavitelnou kloubovou hlavou

i **1**
Další informace

M 30

1-360 - 2,030 mm

360°

Teleskopická podstavná podpěra

3050,-

160.0342

i **1**
Další informace

400 mm

400 mm

2500,-

700.1465 Zkoušečka vůle nápravy

i **1**
Další informace

960 mm

4230,-

700.1495 Univerzální páka na nápravy s řetězem

i **6**
Další informace

HORKÝ PŘÍSTROJ

160 mm

Ø 50 mm

170 mm

Ø 40 mm

160 mm

Ø 30 mm

750 mm

120 mm

Ø 56 mm

1000 W

11300,-

500.8480 Souprava indukční horkovzdušné pistole



i **22**
Další informace

42 40 38 36 34
32 30 28 26 24
#1 #2 #3 #4
M12 M10 TR20
M12 M10

700.2355 **Souprava stupňovitých tlakových pouzder**

18400,-

i **37**
Další informace

1 x 2 x 9 x 13 x
Ø1: 34 - 80 mm Ø2: 44 - 90 mm
Ø 38 - 40 - 42 - 50 - 52 - 54 - 62 - 64 - 66 mm
Ø 34 - 36 - 44 - 46 - 48 - 56 - 58 - 60 - 68 - 70 - 72 - 75 - 80 mm
M10x1,5
M12x2,0
M14x2,0
M16x2,5

700.1550 **Souprava tlačných a tažných objímek**

7500,-

i **4**
Další informace

30-35 mm 35-40 mm 40-45 mm
360 mm
1/2" / 32 mm

150.1125 **Souprava speciálních klíčů na axiální klouby**

2000,-

i **30**
Další informace

1 x Ø 90 - 130 mm
1 x 4 x M 14
4 x M12 x 1,25
M12 x 1,5
4 x M12 x 1,25
M12 x 1,5
M14 x 1,5
1 x M18 x 2,5 x 230 mm M57 x 2
4,3 Kg

5630,-

700.1530 **Souprava univerzálních stahováků na náboje kol a kloubové hřídele**

i **1**
Další informace

380,-

Ø 20 mm

150 mm

150.2199 Přístroj k testování brzdové kapaliny

i **1**
Další informace

VITON®
FKM

700,-

150.8258 Rozprašovací lahev na čisticí přípravek na brzdy

Určeno pro čističe brzdy

i **2**
Další informace

280,-

150.1935 Souprava univerzálních háčků, tvarovatelné

i **2**
Další informace

380,-

150.2235 Souprava univerzálních háčků, tuhé

i **12**
Další informace

1700,-

1/2" 11,5 mm 14 mm 15 mm 20 mm AS 22 mm

1/4" 9 x 20 mm

3/8" 7 x 72 mm
7 x 92 mm
9 x 50 mm
11 x 100 mm

3/8" 7 x 25 - 8 x 25 mm

150.2400 Souprava speciálních nástrčných ořechů na šroubové spoje brzdových třmenů

i **41**
Další informace

2500,-

150.1970 Souprava nářadí ke zpětnému nastavení pístů brzdových válců



Další informace

UNIVERZÁLNÍ GÉNIUS

UNIVERSAL
Pro 95 % všech vozidel



3250,-

150.2440 Souprava univerzálního nářadí ke zpětnému nastavení pístů brzdových válců



Další informace

17500,-



5L



160.0700 Přístroj na údržbu brzd KS5

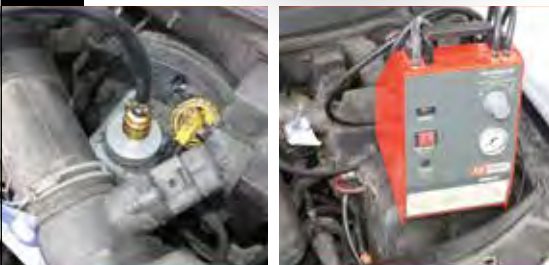

Další informace



UNIVERZÁLNĚ NASTAVITELNÉ



Max. 70 mm

Min. 28 mm

1500,-

160.0718 Univerzální adaptér na odvzdušňovací hrdla, nastavitelný



i  **6**
Další informace

STOP

1.200 mm

1750,-

11 mm
10 mm
9 mm
8 mm
7 mm

160.0725 Souprava klíčů k odvzdušnění brzd

i  **1**
Další informace

4,75 mm (3/16")

21 mm
31 mm
41 mm
61 mm
76 mm

1000,-

120.1006 Ohýbací nářadí na brzdová vedení

i  **1**
Další informace

4,75 mm (3/16")
6,35 mm (1/4")

750,-

120.1004 Rovnací/ohýbací nářadí na brzdová vedení

1 Ohýbání
2 Kopírování
3 Rovnání

OUT IN

i  **4**
Další informace

1250,-

122.1215 Souprava univerzální obrubovačky na brzdové vedení FLAREFIXeco 4,75 mm



Další informace

FLAREFIX



DIN
SAE

4250,-



3,0-40,0 mm

3,0-6,0 mm

3,0-16,0 mm

4,75-5,0 mm, OP1, SAE

4,75 mm, 3/16"

6,0 mm, OP1, SAE

4,75-5,0-6,0 mm, OP2

4,75-5,0 mm

5,0 mm

6,0 mm

6,0 mm

122.1290

Univerzální souprava obrubovačky s hydraulickým vřetenem FLAREFIX 1



Další informace

FLAREFIX II



Hydraulic

7500,-



DIN
SAE



M12 x 1,25 mm

4,75-5,0 mm, OP1, SAE

6,0 mm, OP1, SAE

4,75-5,0-6,0 mm, OP2

4,75-5,0 mm

6,0 mm

M12x1,25

4,75 mm, 3/16"

5,0 mm

6,0 mm



122.1260

Univerzální souprava obrubovačky s hydraulickým válcem FLAREFIX 2



Další informace



3/8"



1 Ford/PSA



2 BMW



3 VAG



4 Mercedes



5 DAF/MAN



6 GM **NOVINKA**



7 Ford **NOVINKA**



8 Ford **NOVINKA**



9 Ford



630,-

Souprava speciálních profilů na výměnu oleje 3/8",
na vypouštěcí šrouby oleje z umělé hmoty, 9dílná

150.1040



Další informace



Ø 385 mm

330,-

150.9359 Záchytná vana, 7,5 l



Další informace

PRO VAG



2,0 L



- ideálně vhodné k čistému a odbornému naplnění šetrně k životnímu prostředí
- přímé a těsné spojení s plnicím otvorem oleje
- zamezení vylití a znečištění motorového oleje nebo sběrného výfukového potrubí vylitým olejem
- otočné úhlové rameno pro práci na obtížně přístupných místech

• otočné úhlové rameno pro práci na obtížně přístupných místech



380,-

150.9155 Souprava plnicích trychtyřů na olej s otočným úhlovým ramenem, pro vozidla VAG



Další informace

UNIVERZÁLNÍ



1/2" 21 mm
Ø 63 - 102 mm

3/8"



65-14, 65/67-14, 66-6, 68-14, 73-14, 74-15, 74/76-15, 75/77-15, 76-8, 76-12, 76-14, 76-30, 78-15, 80-15, 80/82-15, 86-18, 86-16, 90-15, 92-10, 93-15, 93-36, 93-45, 95-15, 96-18, 100-15, 106-15, 108-15, 108-18

2500,-

150.9350 Souprava klíčů na olejové filtry 3/8"



Další informace

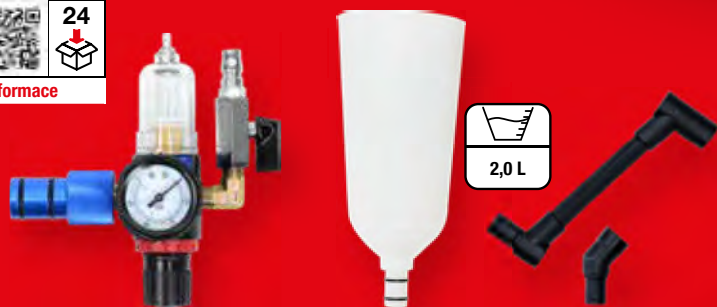

2,0 L



2500,-

- včetně bajonetového adaptéru a adaptéru pro platformu VAG-MQB
- přímé a těsné spojení s plnicím otvorem oleje
- otočné úhlové rameno pro práci na obtížně přístupných místech
- ideálně vhodné k čistému a odbornému naplnění šetrně k životnímu prostředí
- zamezení vylištění a znečištění motorového oleje nebo sběrného výfukového potrubí vylištěným olejem

150.9130 MASTER Souprava plnicích trychtýřů na olej s otočným úhlovým ramenem





Další informace

- ideální podložka k ochraně prahů dveří a laku
- optimální neklouzavost
- univerzální opěrná plocha pro zvedáky
- optimální pro karosárny, zvedáky v pneuservisech, atd.
- mimořádně robustní provedení pro všestranné použití

1000,-

Souprava univerzálních pryžových podložek pro zvedáky

160.0391-TD

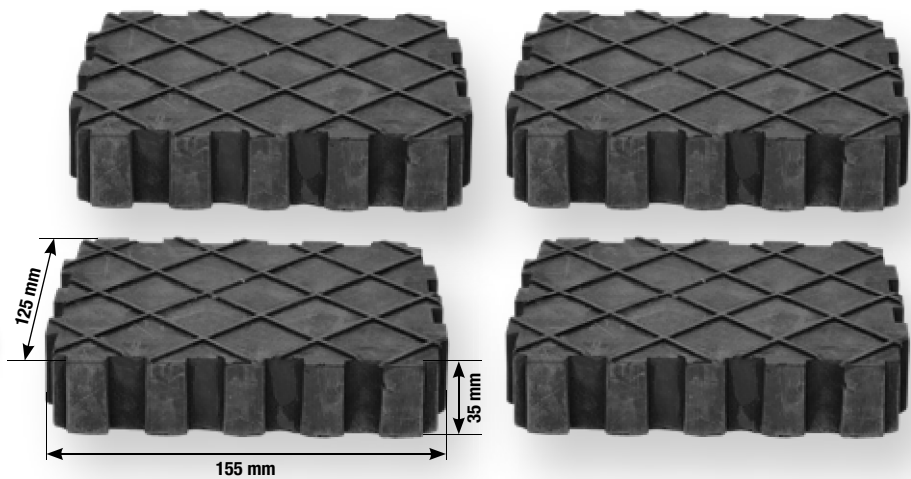

Další informace

200,-

800.0156 Magnetická miska z umělé hmoty, Ø 150 mm



Další informace

250,-

150.2032 Kovové zdvihátko ventilů pneumatik, 330 mm



Další informace

1250,-

800.0190 Kovový držák na magnety, 390 mm



Další informace

700,-

911.8135 Páka k výměně a montáži pneumatik typu Runflat



i  **1**
 Další informace



600 mm

0 - 12 bar

500,-

1/4" PT

515.1950 Pneumatický měřič tlaku v pneumatikách a hustičí zařízení, 0 – 12 bar

i  **1**
 Další informace



400 mm

0 - 10 bar

1550,-

1/4" PT

kalibrováno

515.1960 Cejchovaný pneumatický měřič tlaku v pneumatikách a hustičí zařízení, 0 – 10 bar

i  **5**
 Další informace



1430,-

VOLITELNĚ
 60 ks
450,-
 150.1072

150.1070 Vulkanizační sada na opravu pneumatik, včetně vláken 100 mm



- 1
- 2
- 3
- 4
- 5
- 6
- 7

i  **1**
 Další informace



2250,-

Souprava brusky na hliníkové náboje kol s Ø 150 mm, vnitřní Ø 90 mm

90 mm

150 mm

VOLITELNĚ
880,-
 100.5077



i  **3**
Další informace



Souprava silových nástrčných ořechů se spirálovým profilem, 3dílná, 17-21 mm

1000,-

913.1270 $\frac{1}{2}$ " 17 - 19 - 21 mm

i  **10**
Další informace



Souprava k demontáži pojistek kol

17 mm 3 x
 180 mm
 22 mm
 8 x 18 - 19 - 20 - 21 - 22 - 23 - 24 - 25 mm

1500,-

913.1480 \bigcirc 18 - 19 - 20 - 21 - 22 - 23 - 24 - 25 mm

i  **2**
Další informace



Souprava speciálních silových nástrčných ořechů na hliníkové ráfky, pro vozidla Ford, 18,5/19,5/20,5/21,5 mm

700,-

515.0895 $\frac{1}{2}$ " \bigcirc 18,5 - 19,5 - 20,5 - 21,5 mm

i  **1**
Další informace

PRO ZNAČKU MERCEDES
 max. 75 Nm



450,-

Silový torzní nástavec 1/2", 75 Nm

515.1491 $\frac{1}{2}$ "

SOUPRAVA ROBUSTNÍCH SILOVÝCH NÁSTRČNÝCH OŘECHŮ NA HLINÍKOVÉ RÁFKY 1/2"

1

i **3**

Další informace



450,-

515.1070 1/2" 17 - 19 - 21 mm

2

i **5**

Další informace



630,-

515.0870 1/2" 15 - 17 - 19 - 21 - 22 mm

3

i **10**

Další informace

1750,-



1/2" 15 - 17 - 19 - 21 - 22 - 23 - 24 mm

7/8" 17 mm MS21

4

i **17**

Další informace



3500,-

UNIVERZÁLNÍ VŠEUMĚL

515.0885 1/2" 15 - 17 - 19 - 21 - 22 - 23 - 24 mm 7/8" 17 mm MS21 17 - 19 - 21 mm 18,5 / 19,5 - 20,5 / 21,5 - 17,5 / 22,5 mm

	515.1072 15 mm	515.1073 17 mm	515.1075 19 mm	515.1076 21 mm	515.1077 22 mm	515.1078 23 mm	515.1079 24 mm	515.1089 Tesla 7/8"	515.2055 Mercedes 17 mm	515.2060 Hyundai KIA MS21	913.1271 Spratový ořech k vysrubování 17 mm	913.1272 Spratový ořech k vysrubování 19 mm	913.1273 Spratový ořech k vysrubování 21 mm	515.0896 Ford 18,5 / 19,5 mm	515.0897 Ford 20,5 / 21,5 mm	515.0899 Ford 17,5 / 22,5 mm	515.1134 Silový nástavec, 75 mm
1	X	✓	✓	✓	X	X	X	X	X	X	X	X	X	X	X	X	X
2	✓	✓	✓	✓	✓	X	X	X	X	X	X	X	X	X	X	X	X
3	✓	✓	✓	✓	✓	✓	✓	✓	✓	✓	X	X	X	X	X	X	X
4	✓	✓	✓	✓	✓	✓	✓	✓	✓	✓	✓	✓	✓	✓	✓	✓	✓



Další informace

- přesnost vypnutí: $\pm 3\%$ od nastavené hodnoty na stupnici
- opakovatelnost a přesnost při minimálně 5 000 změnách zatížení
- pro kontrolované utažení doprava a doleva
- zřetelně slyšitelné a cítelné uvolnění utahovacího momentu krátkým vypnutím
- rychlé a jisté nastavení utahovacího momentu otáčením rukojeti



3100,-

20-200 Nm



Všechny průběhy a změny jsou zaznamenány
DIN EN ISO 6789
Certifikát
#1404002
10.01.2023

1/2"

500 mm

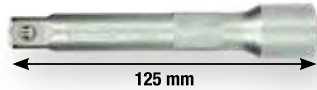

125 mm



10 mm 13 mm 17 mm 19 mm 21 mm 24 mm 17 mm 19 mm 21 mm

516.2400 1/2" 10 - 13 - 17 - 19 - 21 - 24 mm



1/2" 1600 Nm 2,1 KG

1.600 Nm



1/2"

+

4X

Ø 150 mm



Ø 400 mm

515.1205 2500,-



i **1** max. 8 h 4,5 h 95 g

Další informace

USB-C **Senzorový spínač** **MAX. 350 Lumenů** **MAX. 100 Lumenů** **270°**

On/Off **Nastavení velikosti** **COB LED 3 stupně intenzity osvětlení**

Power Display **Pohybový senzor** **XPE LED 2 stupně intenzity osvětlení**

**TO MUSÍTE MÍT!
DO DÍLNY NEBO NA VEN**

380,-

150.4520

Modi	COB 100%	COB 40%	COB rot	XPE 100%	XPE 40%
LED	270° 3 Watt COB LED			1 Watt High Power XPE LED	
	350 LM	150 LM	-	100 LM	40 LM
	3 h	6 h	8 h	4 h	8 h

i **1** 25 m max. 10 h IPX3

Další informace

85 Lumenů **140 mm** **25 m**

**Kapesní svítidla
perfectLight, 85 lumenů**

380,-

150.4370

i **1** **Další informace**

500 Lumenů **250 Lumenů**

**HYBRID
MEZI
SVÍTLNAMI**

BUĎ
Li-Ion akumulátor s kapacitou
1200 mA (součástí balení)

NEBO
3x baterie AAA
(není součástí dodávky)

360° **180°** **USB**

450,-

150.4510

	20%	
	40%	
	60%	
	80%	
	100%	

Včetně funkce USB powerbanky

i **1** **Další informace**

Nabíjení USB-C kabelem (součástí balení)

430,- **350 Lumenů**

165 mm

UV LED

Inspekční LED svítidla COB Stripe, 350 lumenů s UV bodovým LED světlem a laserovým ukazovátkem

150.4400

